

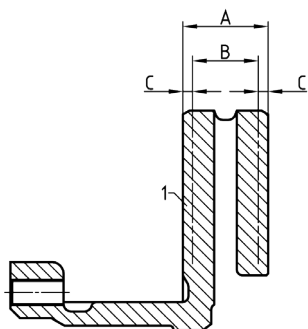

Brake disk wear limit / wear patterns

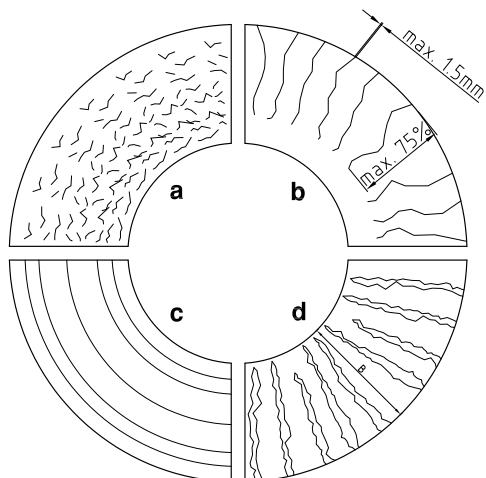

A = NEW	45 mm
B = Brake disk wear limit	37 mm
C = Wear on either side	4 mm



Check brake disks for groove and crack marks. The illustration shows four different wear patterns on a brake disk.

- a) Grid-like crack formation is allowed.
- b) Cracks max. 1.5 mm deep and wide are allowed on the braking surface as long as no more than 75% of braking surface are affected.
- c) Groove marks up to 1.5 mm deep are allowed on the braking surface.
- d) Brake disks must not have cracks all across the braking surface; replace both brake disks on an axle if they do.

Cracks max. 1.5 mm deep and wide are allowed on the braking surface as long as no more than 75% of braking surface are affected.

Brake disks must not have cracks all across the braking surface or through to the cooling duct; replace both brake disks on an axle if they do.

Brake disks under increased thermal load (crimson colouring of cooling duct) No cracks through to the cooling duct Replace both brake disks on an axle if there are any.

