

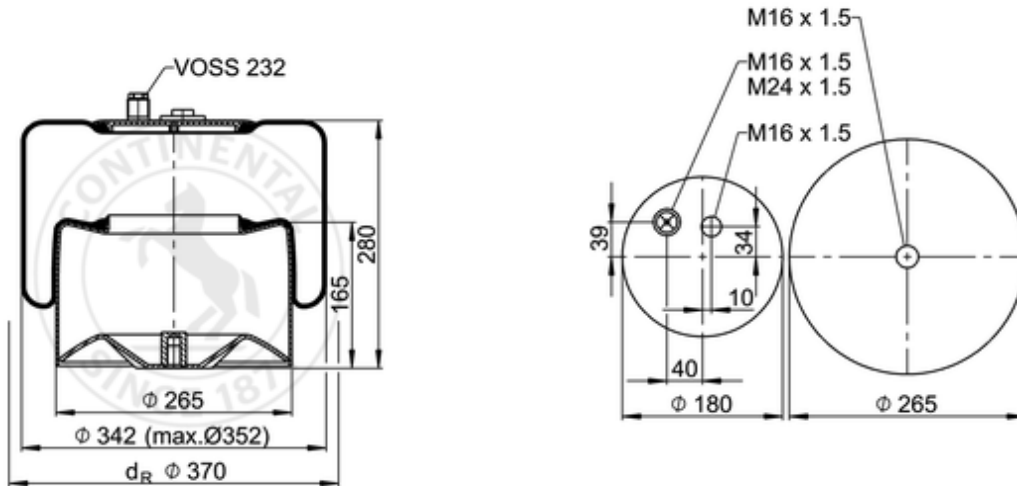











4183 N P28

600135



 bolt or stud  
  hole  
  combination stud  
  air inlet  
  stud and nut

	9,3 kg
	78006
	K036
	
	M16x1.5: max. 130 Nm
	M16x1.5: max. 20 Nm
	M24x1.5: max. 25 Nm

### OE Manufacturer/Part No.

Manufacturer	Original Part No.	Model
Mercedes	942 320 05 57	
Mercedes	942 320 14 21	
Mercedes	942 320 23 21	
Mercedes	942 320 69 21	

Mercedes	A 942 320 14 21	Actros
Mercedes	A 942 320 14 21	Actros
Mercedes	A 942 320 23 21	Actros MP2
Mercedes	A 942 320 69 21	Actros MP2
Mercedes	A 942 320 05 57	Actros MP2
Mercedes	A 942 320 23 21	Actros MP2
Mercedes	A 942 320 69 21	Actros MP2
Mercedes	A 942 320 05 57	Actros MP2