

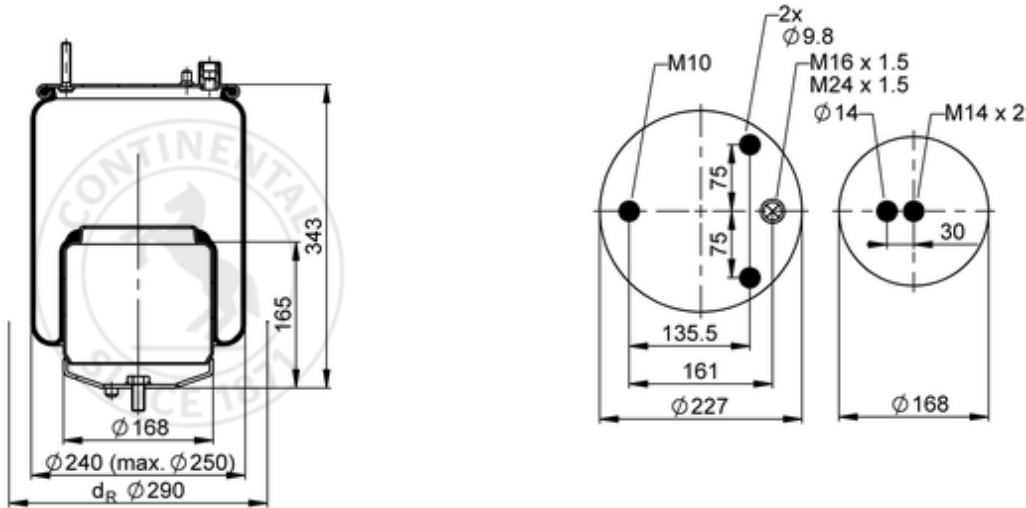











4570 N P02

75811



 bolt or stud
  hole
  combination stud
  air inlet
  stud and nut

| | |
|--|---------------------|
|  kg | 6,2 kg |
|  | |
|  | M10: max. 40 Nm |
|  | M14: max. 120 Nm |
|  | M16x1.5: max. 20 Nm |
|  | M24x1.5: max. 60 Nm |

OE Manufacturer/Part No.

| Manufacturer | Original Part No. | Model |
|--------------|-------------------|------------------|
| Volvo | 22 058 741 | FM / FH std/high |