

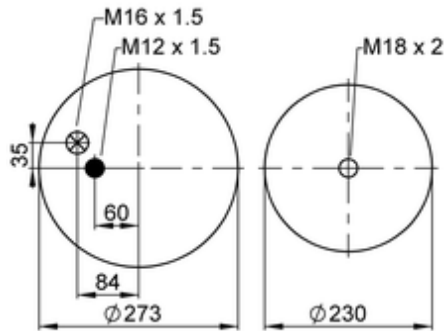

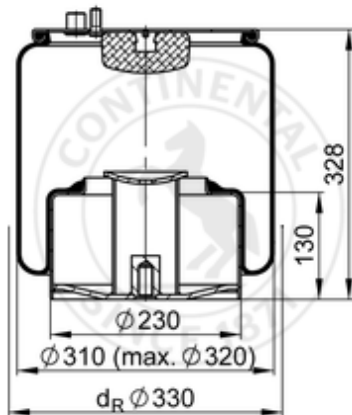









4705 N1 P04

76466



-  bolt or stud
-  hole
-  combination stud
-  air inlet
-  stud and nut

	11,6 kg
	65637
	K032
	
	M12x1.5: max. 40 Nm
	M16x1.5: max. 20 Nm
	M18x2: max. 180 Nm

OE Manufacturer/Part No.

Manufacturer	Original Part No.	Model
MAN	81.43600.6040	TGA ALV 11.5/7.5. 12/8
MAN	81.43600.6040	TGA ALV 11.5/7.5. 12/8

