

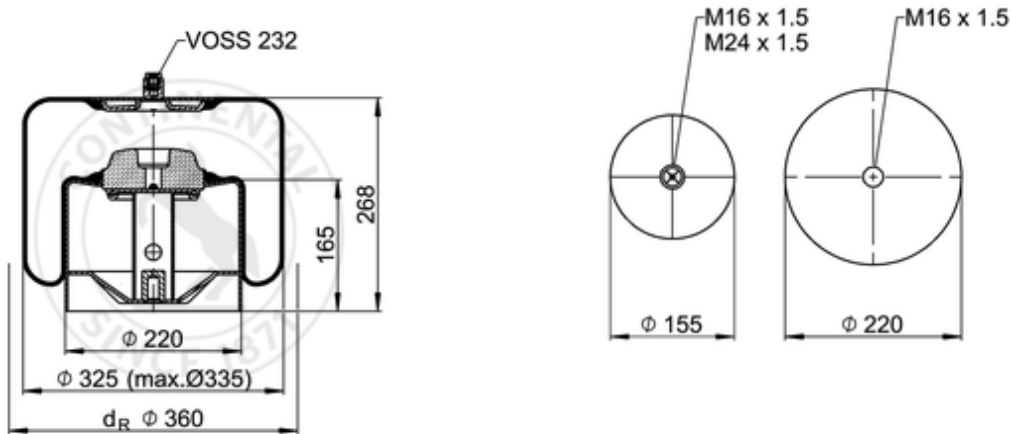









4737 N P21

600169



-  bolt or stud
-  hole
-  combination stud
-  air inlet
-  stud and nut

	9,4 kg
	63081
	K021
	
	M16x1.5: max. 130 Nm
	M24x1.5: max. 100 Nm

OE Manufacturer/Part No.

Manufacturer	Original Part No.	Model
Mercedes	946 320 03 21	
Mercedes	942 320 37 21	
Mercedes	A 946 320 03 21	Atego
Mercedes	A 942 320 37 21	Atego
Mercedes	A 942 320 37 21	Atego

Mercedes

A 946 320 03 21

Atego