

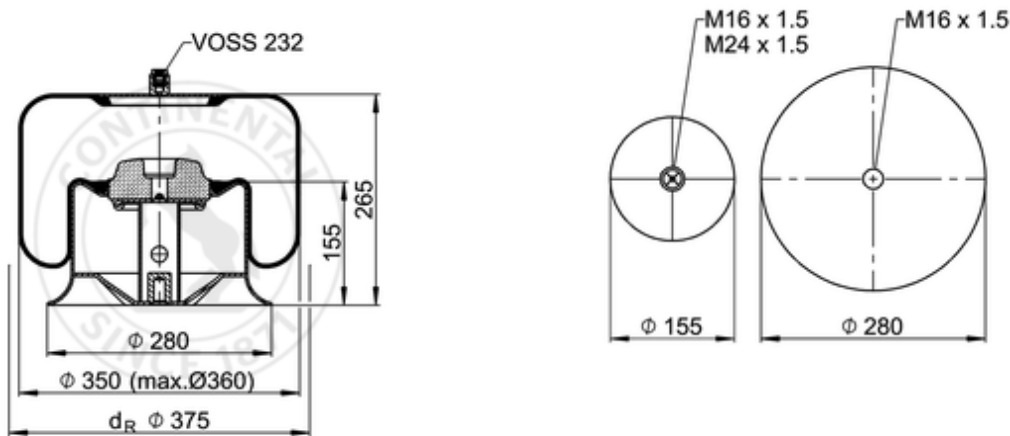











4758 N P23

600188



 bolt or stud
  hole
  combination stud
  air inlet
  stud and nut

 kg	9,3 kg
	66940
	K021
	
	M16x1.5: max. 130 Nm
	M24x1.5: max. 100 Nm

OE Manufacturer/Part No.

Manufacturer	Original Part No.	Model
Mercedes	942 320 06 17	
Mercedes	942 320 33 21	
Mercedes	A 942 320 33 21	Actros MP2
Mercedes	A 942 320 33 21	Actros MP2
Mercedes	A 942 320 06 17	Actros MP2

Mercedes

A 942 320 06 17

Actros MP2