

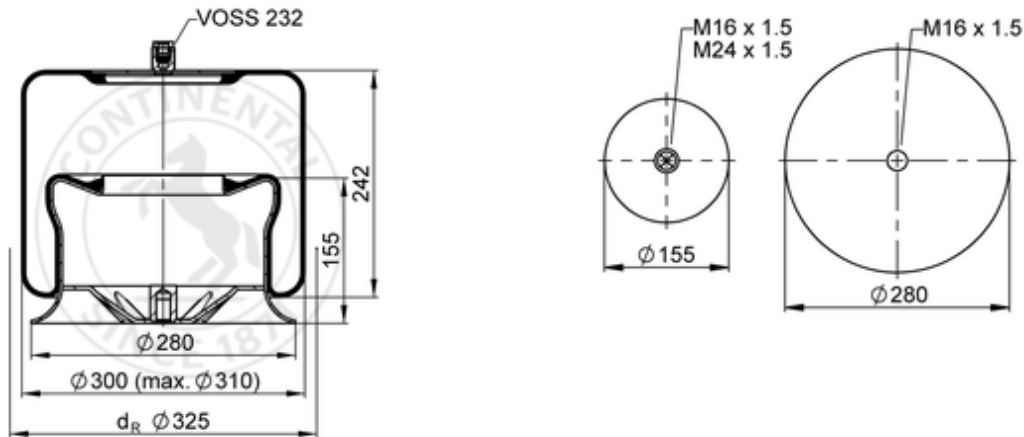











4757 N P21

600177



 bolt or stud   
  hole   
  combination stud   
  air inlet   
  stud and nut

|   |                      |
|---|----------------------|
|  | 7,9 kg               |
|  | 62432                |
|  | K021                 |
|  |                      |
|  | M16x1.5: max. 130 Nm |
|  | M24x1.5: max. 100 Nm |

### OE Manufacturer/Part No.

| Manufacturer | Original Part No. | Model  |
|--------------|-------------------|--------|
| Mercedes     | 942 320 01 17     |        |
| Mercedes     | 942 320 43 21     |        |
| Mercedes     | A 942 320 01 17   | Actros |
| Mercedes     | A 942 320 43 21   | Actros |
| Mercedes     | A 942 320 43 21   | Actros |

Mercedes

A 942 320 01 17

Actros