

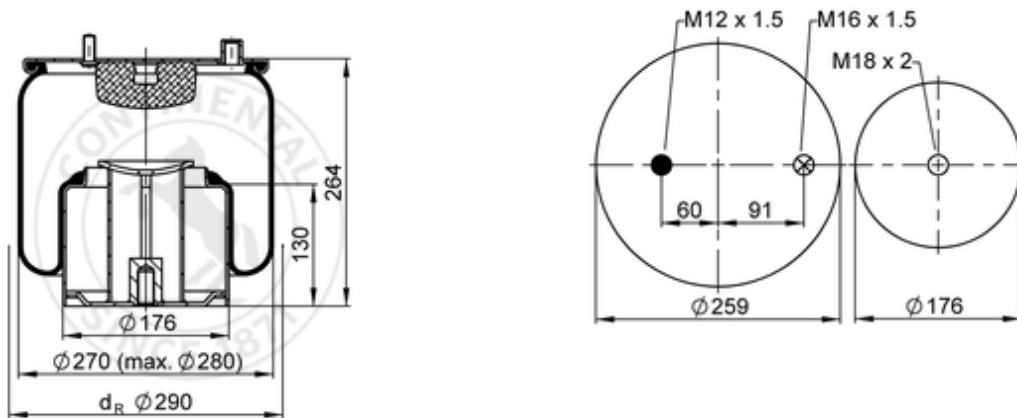











4862 N1 P02

76477



 bolt or stud
  hole
  combination stud
  air inlet
  stud and nut

	8,8 kg
	65718
	K033
	
	M12x1.5: max. 40 Nm
	M16x1.5: max. 40 Nm
	M18x2: max. 180 Nm

OE Manufacturer/Part No.

Manufacturer	Original Part No.	Model
MAN	81.43600.6049	TG1 /TGL
MAN	81.43600.6049	TG1 /TGL

