

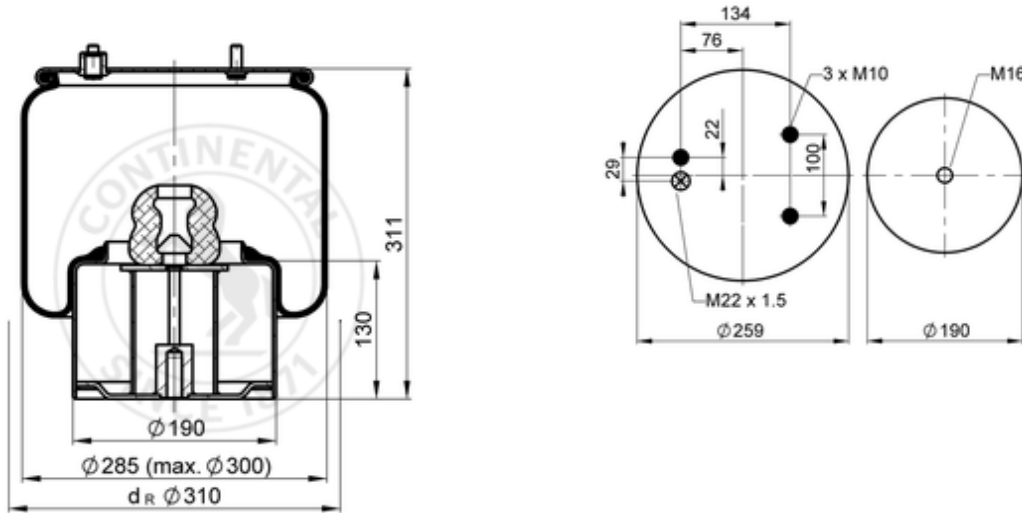









929 N P01

70543



 bolt or stud
  hole
  combination stud
  air inlet
  stud and nut

 kg	8,5 kg
	
	M10: max. 35 Nm
	M16: max. 130 Nm
	M22x1.5: max. 20 Nm

OE Manufacturer/Part No.

Manufacturer	Original Part No.	Model
VDL Bus	30023246	
VDL Bus	45015340	
VDL Bus	5015340	
VDL Bus	5015340	
VDL Bus	45015340	
VDL Bus	30023246	

